

FEATURES

- | Low profile package
- | Ideal for automated placement
- | 600 Watt peak pulse power capability with a 10/1000µs waveform
- | For surface mounted applications to optimize board space
- | Excellent clamping capability
- | Very fast response time
- | Low incremental surge resistance

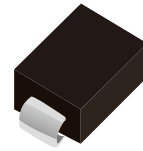

DO-214AA(SMB)

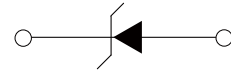

Uni-directional

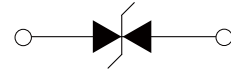

Bi-directional

APPLICATIONS

- | Power supply protection
- | Automotive application
- | Industrial application
- | Power management

APPROVALS

RoHS	Compliance with 2011/65/EU
HF	Compliance with IEC61249-2-21:2003

MAXIMUM RATINGS ($T_A=25^{\circ}\text{C}$)

Parameter	Symbol	Value	Unit
Peak Pulse Power Dissipation on 10/1000us waveform (Note1, Note2).	P_{PPM}	600	Watts
Steady State Power Dissipation at $T_A=50^{\circ}\text{C}$ (Note2).	P_D	5.0	Watts

- Notes :** 1.Non-repetitive current pulse, $T_A=25^{\circ}\text{C}$.
 2.Mounted on 5.0mm*5.0mm (0.03mm thick) Copper Pads to each terminal.

THERMAL CONSIDERATIONS

Parameter	Symbol	Value	Unit
Operating Junction Temperature	T_J	-55 to +150	$^{\circ}\text{C}$
Storage Temperature Range	T_{STG}	-55 to +150	$^{\circ}\text{C}$
Junction to Ambient on printed circuit	$R_{\theta JA}$	90	$^{\circ}\text{C}/\text{W}$

ELECTRICAL CHARACTERISTICS (T_A = 25°C)

Part Number		Device Marking Code		Reverse Stand-off Voltage	Breakdown Voltage Min.@I _T	Breakdown Voltage Max.@I _T	Test Current	Maximum Clamping Voltage @I _{PP}	Peak Pulse Current	Reverse Leakage @V _{RWM}
Uni-Polar	Bi-Polar	Uni	Bi	V _{RWM} (V)	V _{BR} (V)	V _{BR} (V)	I _T (mA)	V _C (V)	I _{PP} (A)	I _R (μ A)
SMBJ3.3A	SMBJ3.3CA	3V3	3V3C	3.3	4.60	5.60	100	8.2	50.0	2000
SMBJ5.0A	SMBJ5.0CA	KE	AE	5.0	6.40	7.00	10	9.2	65.3	800
SMBJ6.0A	SMBJ6.0CA	KG	AG	6.0	6.67	7.37	10	10.3	58.3	800
SMBJ6.5A	SMBJ6.5CA	KK	AK	6.5	7.22	7.98	10	11.2	53.6	500
SMBJ7.0A	SMBJ7.0CA	KM	AM	7.0	7.78	8.60	10	12.0	50.0	200
SMBJ7.5A	SMBJ7.5CA	KP	AP	7.5	8.33	9.21	1	12.9	46.6	100
SMBJ8.0A	SMBJ8.0CA	KR	AR	8.0	8.89	9.83	1	13.6	44.2	50
SMBJ8.5A	SMBJ8.5CA	KT	AT	8.5	9.44	10.4	1	14.4	41.7	20
SMBJ9.0A	SMBJ9.0CA	KV	AV	9.0	10.0	11.1	1	15.4	39.0	10
SMBJ10A	SMBJ10CA	KX	AX	10.0	11.1	12.3	1	17.0	35.3	5
SMBJ11A	SMBJ11CA	KZ	AZ	11.0	12.2	13.5	1	18.2	33.0	1
SMBJ12A	SMBJ12CA	LE	BE	12.0	13.3	14.7	1	19.9	30.2	1
SMBJ13A	SMBJ13CA	LG	BG	13.0	14.4	15.9	1	21.5	28.0	1
SMBJ14A	SMBJ14CA	LK	BK	14.0	15.6	17.2	1	23.2	25.9	1
SMBJ15A	SMBJ15CA	LM	BM	15.0	16.7	18.5	1	24.4	24.6	1
SMBJ16A	SMBJ16CA	LP	BP	16.0	17.8	19.7	1	26.0	23.1	1
SMBJ17A	SMBJ17CA	LR	BR	17.0	18.9	20.9	1	27.6	21.8	1
SMBJ18A	SMBJ18CA	LT	BT	18.0	20.0	22.1	1	29.2	20.6	1
SMBJ20A	SMBJ20CA	LV	BV	20.0	22.2	24.5	1	32.4	18.6	1
SMBJ22A	SMBJ22CA	LX	BX	22.0	24.4	26.9	1	35.5	16.9	1
SMBJ24A	SMBJ24CA	LZ	BZ	24.0	26.7	29.5	1	38.9	15.5	1
SMBJ26A	SMBJ26CA	ME	CE	26.0	28.9	31.9	1	42.1	14.3	1
SMBJ28A	SMBJ28CA	MG	CG	28.0	31.1	34.4	1	45.4	13.3	1
SMBJ30A	SMBJ30CA	MK	CK	30.0	33.3	36.8	1	48.4	12.4	1
SMBJ33A	SMBJ33CA	MM	CM	33.0	36.7	40.6	1	53.3	11.3	1
SMBJ36A	SMBJ36CA	MP	CP	36.0	40.0	44.2	1	58.1	10.4	1
SMBJ40A	SMBJ40CA	MR	CR	40.0	44.4	49.1	1	64.5	9.3	1
SMBJ43A	SMBJ43CA	MT	CT	43.0	47.8	52.8	1	69.4	8.7	1
SMBJ45A	SMBJ45CA	MV	CV	45.0	50.0	55.3	1	72.7	8.3	1
SMBJ48A	SMBJ48CA	MX	CX	48.0	53.3	58.9	1	77.4	7.8	1
SMBJ51A	SMBJ51CA	MZ	CZ	51.0	56.7	62.7	1	82.4	7.3	1
SMBJ54A	SMBJ54CA	NE	DE	54.0	60.0	66.3	1	87.1	6.9	1
SMBJ58A	SMBJ58CA	NG	DG	58.0	64.4	71.2	1	93.6	6.5	1

Part Number		Device Marking Code		Reverse Stand-off Voltage	Breakdown Voltage Min.@I _T	Breakdown Voltage Max.@I _T	Test Current	Maximum Clamping Voltage @I _{PP}	Peak Pulse Current	Reverse Leakage @V _{RWM}
Uni-Polar	Bi-Polar	Uni	Bi	V _{RWM} (V)	V _{BR} (V)	V _{BR} (V)	I _T (mA)	V _C (V)	I _{PP} (A)	I _R (μ A)
SMBJ60A	SMBJ60CA	NK	DK	60.0	66.7	73.7	1	96.8	6.2	1
SMBJ64A	SMBJ64CA	NM	DM	64.0	71.1	78.6	1	103.0	5.9	1
SMBJ70A	SMBJ70CA	NP	DP	70.0	77.8	86.0	1	113.0	5.3	1
SMBJ75A	SMBJ75CA	NR	DR	75.0	83.3	92.1	1	121.0	5.0	1
SMBJ78A	SMBJ78CA	NT	DT	78.0	86.7	95.8	1	126.0	4.8	1
SMBJ85A	SMBJ85CA	NV	DV	85.0	94.4	104.0	1	137.0	4.4	1
SMBJ90A	SMBJ90CA	NX	DX	90.0	100.0	111.0	1	146.0	4.1	1
SMBJ100A	SMBJ100CA	NZ	DZ	100.0	111.0	123.0	1	162.0	3.7	1
SMBJ110A	SMBJ110CA	PE	EE	110.0	122.0	135.0	1	177.0	3.4	1
SMBJ120A	SMBJ120CA	PG	EG	120.0	133.0	147.0	1	193.0	3.1	1
SMBJ130A	SMBJ130CA	PK	EK	130.0	144.0	159.0	1	209.0	2.9	1
SMBJ150A	SMBJ150CA	PM	EM	150.0	167.0	185.0	1	243.0	2.5	1
SMBJ160A	SMBJ160CA	PP	EP	160.0	178.0	197.0	1	259.0	2.3	1
SMBJ170A	SMBJ170CA	PR	ER	170.0	189.0	209.0	1	275.0	2.2	1
SMBJ180A	SMBJ180CA	PT	ET	180.0	201.0	222.0	1	292.0	2.1	1
SMBJ200A	SMBJ200CA	PV	EV	200.0	224.0	247.0	1	324.0	1.9	1
SMBJ210A	SMBJ210CA	PB	ED	210.0	231.0	269.0	1	340.0	1.8	1
SMBJ220A	SMBJ220CA	PX	EX	220.0	246.0	272.0	1	356.0	1.7	1
SMBJ250A	SMBJ250CA	PZ	EZ	250.0	279.0	309.0	1	405.0	1.5	1
SMBJ300A	SMBJ300CA	QE	FE	300.0	335.0	371.0	1	486.0	1.3	1
SMBJ350A	SMBJ350CA	QG	FG	350.0	391.0	432.0	1	567.0	1.1	1
SMBJ400A	SMBJ400CA	QK	FK	400.0	447.0	494.0	1	648.0	0.9	1
SMBJ440A	SMBJ440CA	QM	FM	440.0	492.0	543.0	1	713.0	0.9	1
SMBJ480A	SMBJ480CA	QP	FP	480.0	536.0	593.0	1	750.0	0.8	1
SMBJ500A	SMBJ500CA	QV	FV	500.0	558.0	618.0	1	762.0	0.8	1
SMBJ510A	SMBJ510CA	QX	FX	510.0	570.0	630.0	1	762.0	0.8	1
SMBJ520A	SMBJ520CA	QR	FR	520.0	578.0	640.0	1	762.0	0.8	1
SMBJ550A	SMBJ550CA	QT	FT	550.0	615.0	680.0	1	860.0	0.7	1

CHARACTERISTIC CURVES

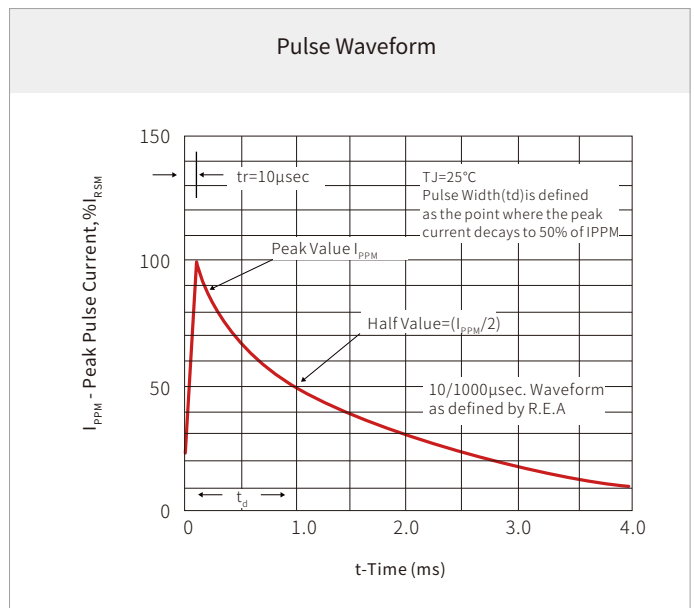
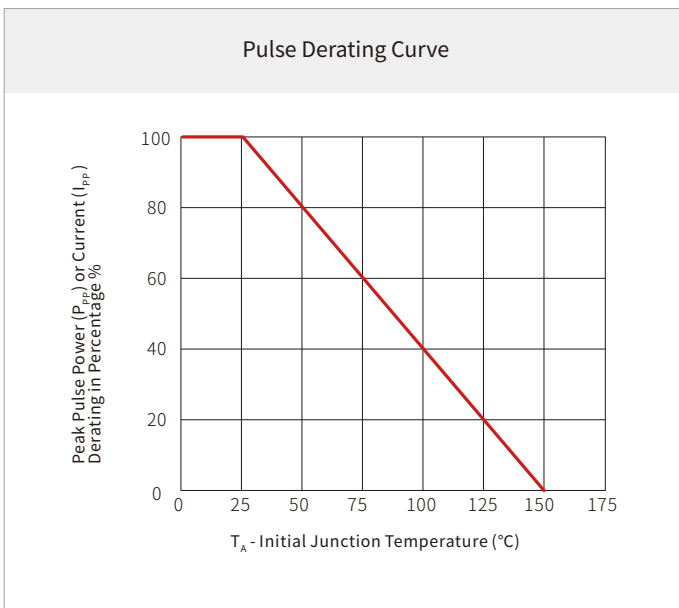
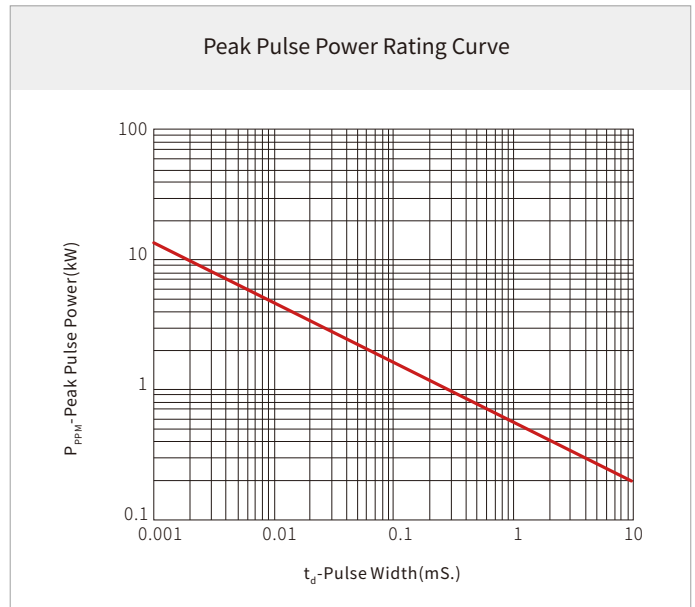
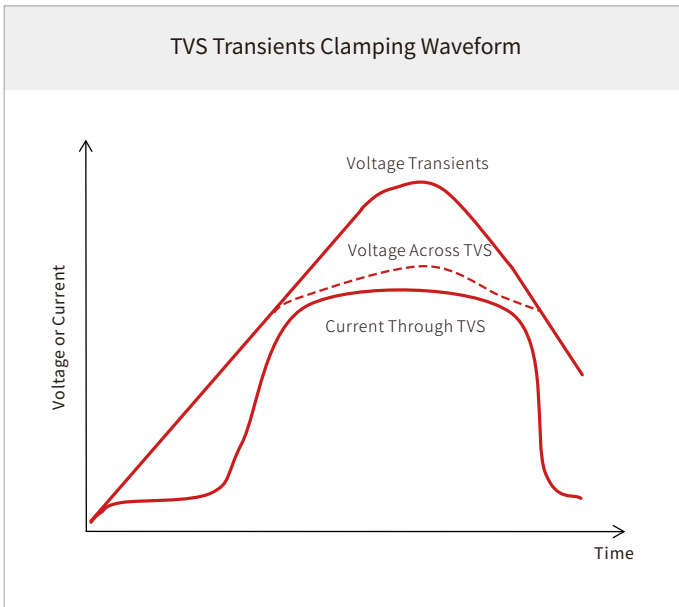

Typical Junction Capacitance

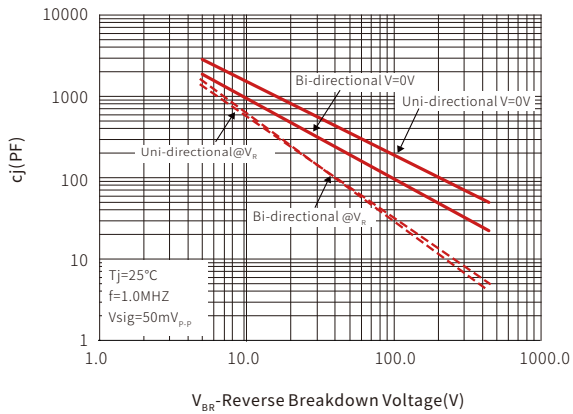

Steady State Power Dissipation Derating Curve

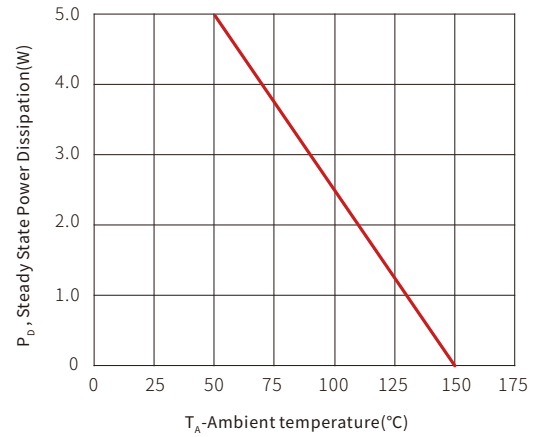

SOLDERING PARAMETERS

Reflow Condition		Lead-free assembly
Pre Heat	Temperature Max ($T_{s(min)}$)	150°C
	Temperature Max ($T_{s(max)}$)	200°C
	Time (min to max) (t_s)	60 – 180 secs
Average ramp up rate (Liquidus Temp (T_L) to peak)		3°C/second max
$T_{s(max)}$ to T_L - Ramp-up Rate		3°C/second max
Reflow	Temperature (T_L) (Liquidus)	217°C
	Time (min to max) (t_r)	60 – 150 seconds
Peak Temperature (T_p)		260°C
Time within 5°C of actual peak Temperature (t_p)		20 – 40 seconds
Ramp-down Rate		6°C/second max
Time 25°C to peak Temperature (T_p)		8 minutes max.
Do not exceed		260°C

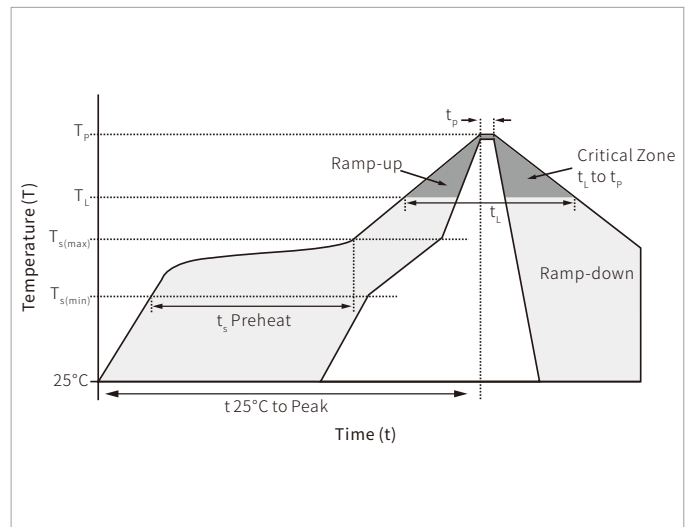

DO-214AA(SMB) PACKAGE INFORMATION

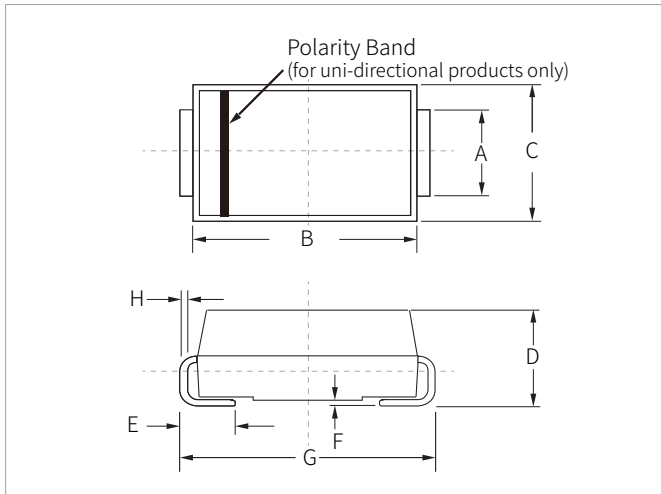

Ref.	Millimeters		Inches	
	Min.	Max.	Min.	Max.
A	1.80	2.20	0.071	0.087
B	4.30	4.70	0.170	0.185
C	3.40	3.90	0.134	0.153
D	2.15	2.75	0.085	0.108
E	1.00	1.50	0.039	0.059
F	0.02	0.20	0.001	0.008
G	5.10	5.50	0.200	0.216
H	0.15	0.30	0.006	0.012

RECOMMENDED PAD LAYOUT DIMENSIONS

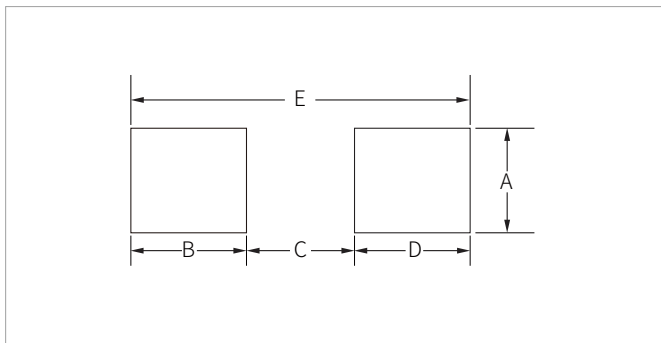

Ref.	Millimeters		Inches	
	Min.	Max.	Min.	Max.
A	2.20	-	0.087	-
B	1.45	-	0.057	-
C	-	2.55	-	0.010
D	1.45	-	0.057	-
E	5.60REF		0.220REF	

ORDERING INFORMATION

Part Number	Component Package	QTY/Reel	Reel Size
SMBJxx(C)A	DO-214AA(SMB)	3000PCS	13"

Headquarters

No.3387 Shendu Road
Pujiang I&E Park
Minhang Shanghai China
201000

Hotline

400-021-5756

Web

<https://www.semiware.com>

Sales Center

Tel: 86-21-3463-7458
Email: sales18@semiware.com

Customer Service

Tel: 86-21-5484-1001
Email: sales17@semiware.com

Technical Support

Tel: 86-21-3463-7654
Email: fae01@semiware.com

Complaint & Suggestions

Tel: 86-21-3463-7172
Ext: 8868
Email: cs03@semiware.com

By QR Code

Website



Wechat

To find your local partner within Semiware' s global website: www.semiware.com

© 2022 Semiware Semiconductor Inc.

The content of this document has been carefully checked and understood. However, neither Semiware nor its subsidiaries assume any liability whatsoever for any errors or inaccuracies of this document and the consequences thereof. Published specifications are subject to change without notice. Product suitability for any area of application must ultimately be determined by the customer. In all cases, products must never be operated outside their published specifications. Semiware does not guarantee the availability of all published products. This disclaimer shall be governed by substantive Chinese law and resulting disputes shall be settled by the courts at the place of business of Semiware. Latest publications and a complete disclaimer can be downloaded from the Semiware website. All trademarks recognized.